



Current Probe P40.3C 2000A-4000A/ 2V

The P40.3C 2000A-4000A/ 2V current probe has been designed for use with multimeters, recorders, power analysers, safety testers etc. for accurate non intrusive measurement of AC/DC current. Using Hall effect technology, the P40.3C 2000A-4000A/ 2V can measure currents from 20 A to 4000 A over a frequency range of DC to 1kHz.



Electrical Characteristics

Current Range I_n	: 2000A and 4000A
Measuring Range.....	: 20 A to 4000 AC/DC
Output Sensitivity.....	: 1 mV / A and 0.5 mV / A
Load Impedance.....	: ≥ 100 kOhm
Conductor Position Sensitivity.....	: 0.5% @ 50Hz
Error due to adjacent conductor.....	: ≤ 10 mA / A @ 50 Hz
Power supply.....	: 9 V Alkaline, 75 Hours, low battery indicator
Output zero.....	: Manual adjust via thumbwheel
Frequency Range.....	: DC Hz to 1 kHz
Working Voltage (see Safety Standards section).....	: 600 V AC _{RMS} or DC

Accuracy

2000A

Primary Current	20 to 100A	100 to 500 A	500 to 1000A	1000 to 2000A
Accuracy (of rdg)	2%+ 3mV	1.5%+3mV	1% +3 mV	1% +3 mV
Phase Error	Non spécifié	<1°	<0.5°	<0.5°

4000A

Primary Current	40 to 100 A	100 to 500A	500 to 2000A	2000 to 4000A
Accuracy (of rdg)	2%+1mV	1.5% +1mV	1% +1 mV	1% +1 mV
Phase Error	3°	2°	1°	1.5°



General Characteristics

Maximum Conductor Size	: 83 mm diameter
Output Connection	: 4 mm sockets
Operating Temperature Range	: 0 to +50 °C
Storage Temperature Range	: -20 to +70°C
Operating Humidity	: ≤ 85%
Weight.....	: 2000 g

Reference conditions: Temperature : +18°C to 26 °C, humidity: 20 to 75% RH, sinusoidal current: 48 to 65Hz, distortion factor: < 1%, DC current: none, DC magnetic field: 40 A/m earth's magnetic field, alternating magnetic field: none, proximity of external conductor: none, primary conductor: centred in the aperture, load impedance: ≥1MΩ, <100pF for voltage output.

Safety Standards

IEC61010-1: 2010
IEC61010-2-032: 2012
IEC61010-2-031: 2008

600 V_{RMS}, Category III, Pollution Degree 2

Use of the probe on **uninsulated conductors** is limited to 600 V AC_{RMS} or DC and frequencies below 1 kHz.

EMC Standards

EN 61326 : 1998

Dimensions

in mm

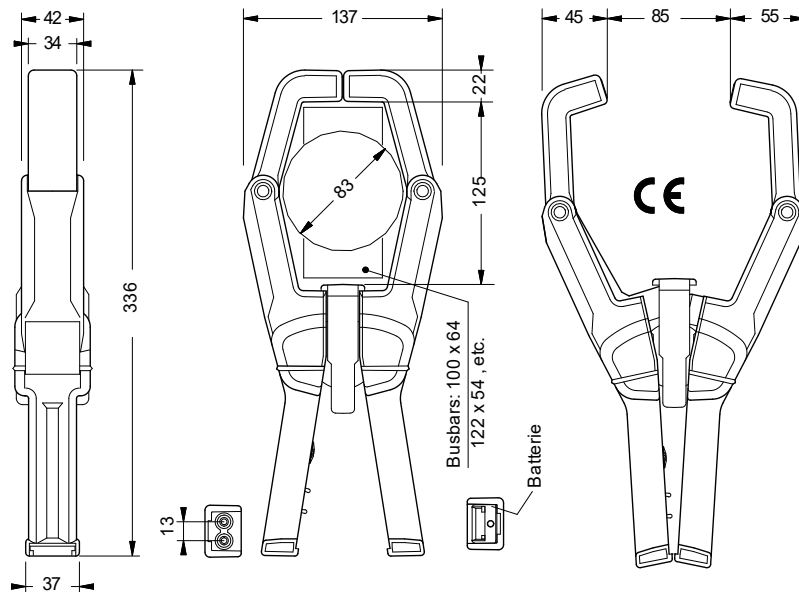

P3C-CLP

Specifications subject to change without notice